

# Ethernet-SPI/DMX Pixel light controller

## User Manual



( Please read through this manual carefully before use )

### 1、Brief Introduction

This Ethernet-SPI/DMX pixel light controller is dedicated to converting the Ethernet signal into SPI pixel signal, which is designed for large project with high-density pixel light, such as matrix panel lights, construction's contour lamp, etc. Besides converting Ethernet-based control protocols into various LED driving IC signal, it also outputs DMX512 signal at the same time, convenient for the connection of different types of led lamp, and to achieve the unified control of all kinds of led lamp in the same project.

### 2、Specifications

Model	204	216
Working Voltage	DC5-DC24V	DC5-DC24V
Output Current	7A X 4CH (Built-in 7.5A fuse )	3A X 16CH (Built-in 5A fuse )
Input Ethernet control protocol	ArtNet	ArtNet
Output Control IC	2811/2801/6803/3001/8806/9813/APA102/TM1814/SK2812 Series	
Control Pixels	RGB : 680 Pixels*4CH RGBW : 512 Pixels*4CH	RGB : 340 Pixels*16CH RGBW : 256 Pixels*16CH
Output DMX512	One port(1X512 Channels)	Two port(2X512 Channels)
Working Temp	-20~55°C	-20~55°C
Product Dimension	L166*W110*H31(mm)	L258*W145*H41(mm)
Weigh(G.W)	510g	1100g

### 3、Basic Features

1

1. With LCD display and built-in WEB SERVER setting interface, easy operation.
2. Support Ethernet DMX protocol ArtNet, can be expanded to other protocols.
3. Multi SPI (TTL) signal output, up to 5440 pixels control.
4. Output DMX512 signal at the same time, convenient for the connection of different types led lamp.
5. Support various LED driving IC, flexible control.
6. Support online firmware upgrade.
7. Adopt DIP plug-in design for the easily-worn parts, Users can repair the damage caused by wrong wiring or short circuit.
8. Built-in test mode, using a network interface with indicator light, work status is clear when at a glance.

### 4、Safety warnings

1. Please don't install this controller in lightning, intense magnetic and high-voltage fields.
2. To reduce the risk of component damage and fire caused by short circuit, make sure correct connection.
3. Always be sure to mount this unit in an area that will allow proper ventilation to ensure a fitting temperature.
4. Check if the voltage and power adapter suit the controller.
5. Don't connect cables with power on, make sure a correct connection and no short circuit checked with instrument before power on.
6. Please don't open controller cover and operate if problems occur.  
The manual is only suitable for this model; any update is subject to change without prior notice.

### 5、Dimensions

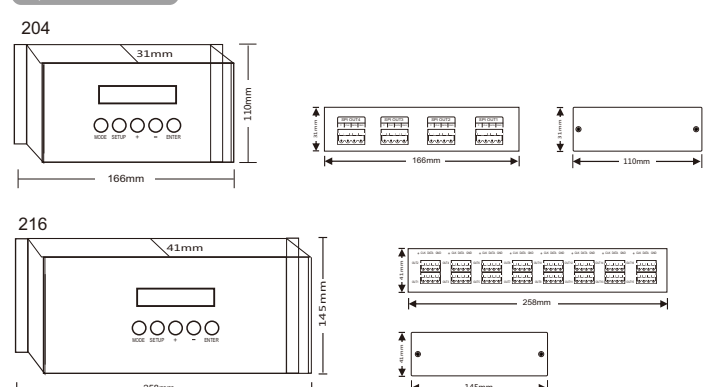

### 6、Operating Instructions

2

### 204 216 Instruction of interface and ports:

Notice: The controller should connect with two power supplies .  
The 1st power supply support SPI 1-8 .  
The 2nd power supply support SPI 9-16 .  
(The two power input can share the same unit power supply when the power is sufficient.)

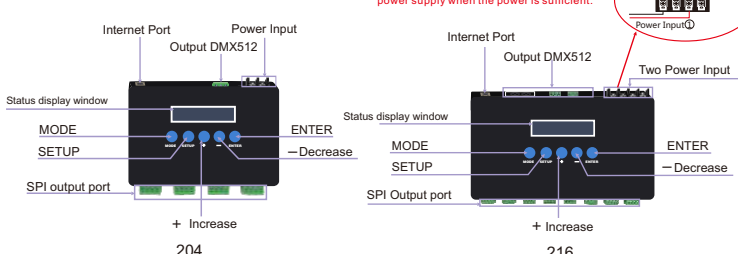

### Wiring instructions of SPI output port :

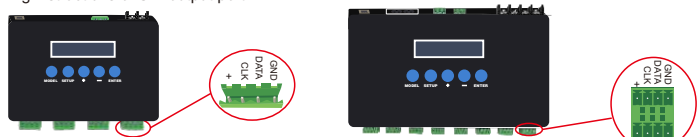

To output LPD6803/LPD8806/P9813/WS2801 controlling signal , it required at least three lines :

DATA	6803/8806/9813/2801 DATA
CLK	6803/8806/9813/2801 CLK
GND	GND , connect with the chip GND

To output WS2811/ TLS3001/TM1814/SK6812 controlling signal, it required at least two lines :

DATA	WS2811/ TLS3001 DATA
GND	GND , connect with the chip GND

Connect the Lamps positive supply to the + of the SPI output ports. .

### 1、Key Description

Button	Short Press Function	Long Press Function
MODE	Switch setting parameter type	Enter test exit mode
SETUP	Enter and switch setup	
+	Increase current set value	Increase current set value rapidly
-	Decrease current set value	Decrease current set value rapidly
Enter	Confirm and enter into next set value	

### 2、Operating and setting instructions

Ethernet-SPI/DMX pixel light controller with two working models , respectively : Normal working mode and test mode.

3

### (1) Normal working mode

Normal mode is based on Ethernet transferring ArtNet protocol into a control signal which can be received by various pixel lamps; Connecting the lamps, plugging the network cable, after checking, power on. The controller will enter into the network detection,

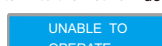

After detecting without problems, the controller will enter into normal working mode and show the IP address. IP address has static and dynamic allocation. STAT for static allocation, DHCP for dynamic allocation, the controller default IP address is static;

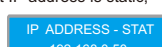

This controller also comes with key lock function, no operation after 30 seconds, the system enters the lock state, then LCD shows



Long press "MODE" to unlock, unlocked before next operation.

### (2). Parameter Setting

In normal working mode, press "MODE" to switch parameter setting type, "SETUP" to enter the setup, then press "ENTER" to get back to previous level.

NO.	Setting	LCD display	Value
1	System setup	1SYSTEM SETUP	
	IP static and dynamic selection	DHCP-YES PRESS OK TO SAVE	YES: Dynamic IP NO: Static IP(Default )
	IP Address	STATIC IP 192.168.0.50	Static IP address (Default) : 192.168.0.50
	Subnet Mask	SUBNET MASK 255.255.0	(Default) : 255.255.255.0
	IC type	PIXEL PROTOCOL 2811	"2811(Default)" "2801" "6803" "3001" "8806" "9813" "APA102" "1814" "6812"
	RGB Sequence	LED RGB SEQ RGB	"RGB(Default)" "RBG" "GRB" "GBR" "BRG" "BGR" "RGBW" "GRWB" "RBGW" "RBWG" "RWGB" "RWBG" "GRBW" "GRWB" "GBRW" "GBWR" "GBWR" "GBWR" "BRGW" "BRWG" "BRGW" "BRWG" "WRGB" "WRGB" "WRGB" "WRGB" "WRGB" "WRGB"
	ArtNet Signal RGB Sequence	SIGNAL RGB SEQ RGB	"RGB( Default)" "BGR"
	Signal configuration	SIGNAL CONFIG ArtNet	Only support ArtNet at present
	LCD background dormancy time selection	LCD Back Light ALWAYS ON	"ALWAYS ON" "1 MINUTE" "5 MINUTES" "10 MINUTES"
	2	Channel 1 setup	2OUT1 SETUP
Universe setup		2OUT1 START UNIVERSE-255	Universe settings range : 1-256

4

DMX Channel	OUT1 START CHANNEL:512	DMX channel range : 1-512 The default value : 1	
Pixel	OUT1 NUM PIXELS:680	204 : Pixel range : 0-680 The default value : 680 216 : Pixel range : 0-340 The default value : 340	
	OUT1 NULL PIXELS:680	204 : Null pixel range : 0-680 The default value : 0 216 : Null pixel range : 0-340 The default value : 0	
	OUT1 ZIG ZAG:680	204 : Zig zag pixel range : 0-680 The default value : 0 216 : Zig zag pixel range : 0-340 The default value : 0	
	OUT1 REVERSED:YES	YES: Reverse control NO (Default): Not reverse control	
	3 Channel 2 setup	3OUT2 SETUP	Same to channel 1
4 Channel 3 setup	4OUT3 SETUP	Same to channel 1	
5 Channel 4 setup	5OUT4 SETUP	Same to channel 1	
6	DMX512 channel setup	6DMX512 OUTPUT	204: One DMX512 channel 216: Two DMX512 channels
	DMX512 output selection	DMX512 OUTPUT YES	YES(Default): Output NO: Not output
	DMX512 universe setup	DMX512 UNIVERSE 255	DMX512 Domain settings range : 1-256
7	Load default	7LOAD DEFAULT	
	Confirm to load default	LOAD DEFAULT YOU SURE?	
8	About	8ABOUT	
	Model	Ethernet-SPI4 ID4009012	

### Control ICs type:

IC Type	Compatible ICs	Type
2811	TM1803, TM1804, TM1809, TM1812, UCS1903, UCS1909, UCS1912, UCS2903, UCS2909, UCS2912, WS2811, WS2812B, SM16703P, GS8206 etc.	RGB
2801	WS2801, WS2803 etc.	
6803	LPD6803, LPD1101, D705, UCS6909, UCS6912 etc.	
3001	TLS3001, TLS3002 etc.	
8806	LPD8803, LPD8806 etc.	
9813	P9813 etc.	
APA102	APA102 etc.	RGBW
TM1814	TM1814 etc.	
SK6812	SK6812, UCS2904, P9412 etc.	

### (3) Test mode

Long press "MODE" to enter the test mode, press it again to exit, after entering the test mode, press "+" "-" to switch the mode and "SETUP" to set the parameter of the current mode. After enter into test mode, the LCD will show operation tips, as below:



5

NO.	Built-in sequences	NO.	Built-in sequences
1	Solid color: Black(Off)	13	Blue chase with trail
2	Solid color: Red	14	Rainbow chase - 7 Colors
3	Solid color: Green	15	Green chasing Red, chasing Black
4	Solid color: Blue	16	Red chasing Green, chasing Black
5	Solid color: Yellow	17	Red chasing White, chasing Blue
6	Solid color: Purple	18	Orange chasing Purple, chasing Black
7	Solid color: CYAN	19	Purple chasing Orange, chasing Black
8	Solid color: White	20	Random twinkle: White over red background
9	RGB CHANG	21	Random twinkle: White over blue background
10	full COLOR CHANGE	22	Random twinkle: White over green background
11	Red chase with trail	23	Random twinkle: White over purple, background
12	Green chase with trail	24	Random twinkle: White over orange background

### 3、WEB setting, Firmware upgrading online.

In addition to set parameters by buttons, you can also set it through the Web browser of computer. The parameter settings between the two are the same;

WEB operation instructions:

Open the web browser of the computer, which is in the same LAN with the controller, input the IP address (such as the default IP: 192.168.0.50), and press "Enter" to browse the controller's built-in website, as shown below:

### User Login

Controller Name: Ethernet-SPI4  
 Password: 12345  
 Note - Default Password: 12345  
 Login

Enter the default password : 12345 , Click Login to enter the parameter setting page. The users can set the parameter and upgrade the firmware on website.

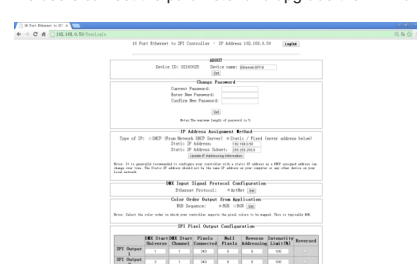

6

### Upgrade the firmware online:

To find the column "Firmware Update" on website (as below)



Then click After downloading updated firmware to Computer - Click to Update Firmware , to enter the firmware update page(as below) ; click Choose file , then choose the BIN file you need to upgrade, then click Update enter into firmware updating page, After upgrade, the website will auto matically back to the login screen.

### 7、Conjunction Diagram

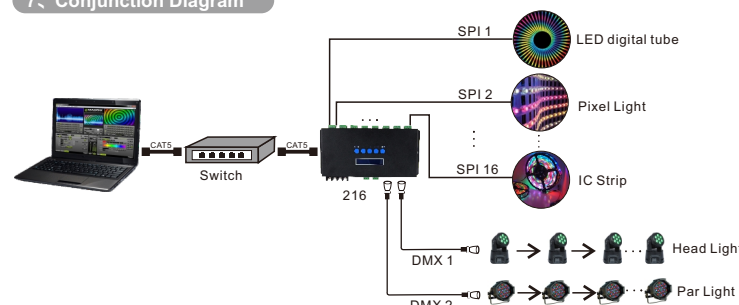

7

### 8. After-Sales

From the day you purchase our products within 3 years, if being used properly in accordance with the instruction, and quality problems occur, we provide free repair or replacement services except the following cases:

1. Any defects caused by wrong operations.
2. Any damages caused by inappropriate power supply or abnormal voltage.
3. Any damages caused by unauthorized removal, maintenance, modifying circuit, incorrect connections and replacing chips.
4. Any damages due to transportation, breaking, flooded water after the purchase.
5. Any damages caused by earthquake, fire, flood, lightning strike etc force majeure of natural disasters.
6. Any damages caused by negligence, inappropriate storing at high temperature and humidity environment or near harmful chemical

8